

STANDARD SEALS

STANDARD ALUMINUM RETAINERS

Made of high-strength aluminum and designed to hold any 1/2" to 3" standard brush, rubber or vinyl seal (see pages 3, 4 & 5). Custom fabrication and secondary options include punching and assembly.

STANDARD MILL LENGTHS: 8'-2", 9'-2", 10'-2", 12'-4", 14'-4", 16'-4", 18'-4"

STANDARD BROWN & WHITE LENGTHS: 16'-4", 18'-4"

PART NUMBER	COLOR
1" STR	
A0088-MI-W	Mill
A0088-BR-W	Brown
1" 45°	
A0082-MI-W	Mill
A0082-BR-W	Brown
A0082-WH-W	White
1" 90°	
A0087-MI-W	Mill
1" Reverse 45°	
A0085-MI-W	Mill
2" STR	
A0288-MI-W	Mill
A0288-BR-W	Brown
2" 45°	
A0282-MI-W	Mill
A0282-BR-W	Brown
A0282-WH-W	White
2" OFFSET	
A0083-MI-W	Mill
3" OFFSET	
A0086-MI-W	Mill

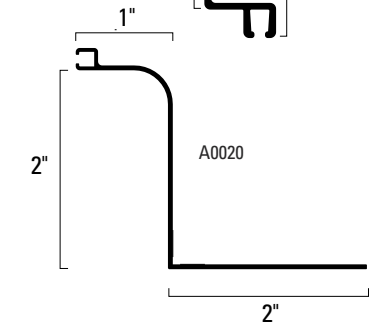
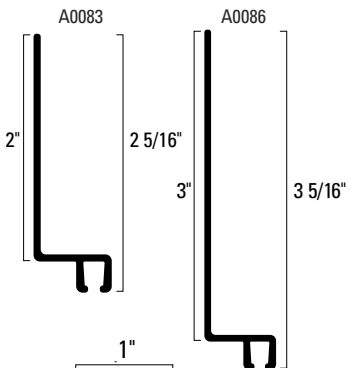
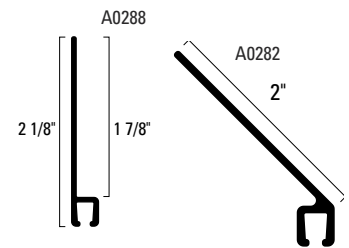
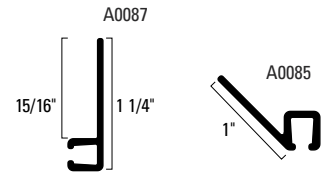
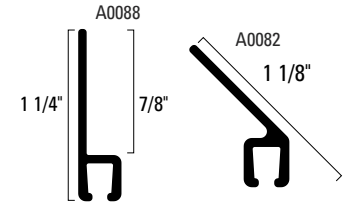

ROLLING STEEL "Z" HEADER SEAL RETAINER

16'4" and 18'4" Only

PART NUMBER	COLOR
A0020-MI-W	Mill

STANDARD ROLLING STEEL GUIDE SEAL

Designed to clip onto guides up to 1/4" thick. Compatible with standard brush, rubber and vinyl seals (see pages 3, 4 & 5).

STANDARD LENGTHS: 8'-2", 16'-4", 18'-4"

PART NUMBER	COLOR
PL035-00-W	Gray

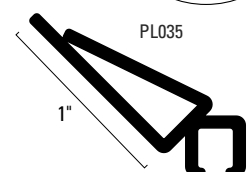
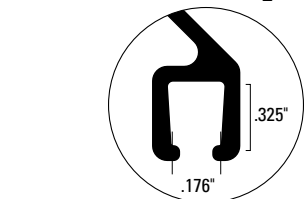

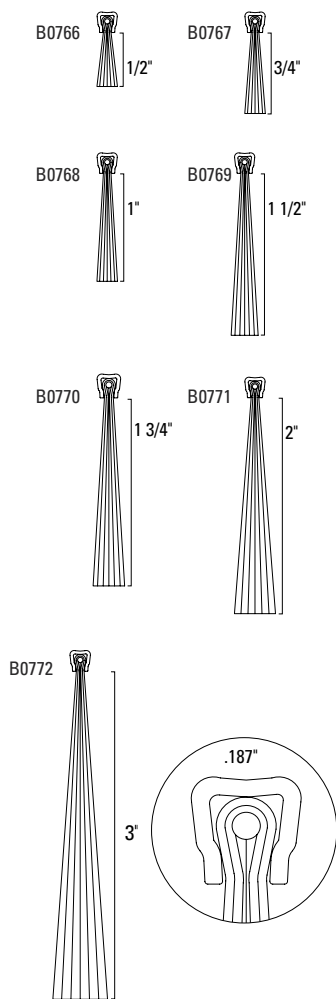

STANDARD & ZEBRA BRUSH SEALS

Both our Standard and Zebra Brush™ Seals are made of versatile and long-lasting filaments that will not hold water or freeze at sub-zero temperatures. Bristles are wrapped around a steel rod to prevent “pull-out.” Standard Brush Seals fit all Standard Aluminum Retainers (see page 2) or Standard Rolling Steel Clip-On Retainers (see page 23). STANDARD LENGTHS: 6', 7', 8', 9', 10'.

PART NUMBER	BRISTLE
STANDARD BRUSH SEAL	
B0766-00-W	1/2"
B0767-00-W	3/4"
B0768-00-W	1"
B0769-00-W	1 1/2"
B0770-00-W	1 3/4"
B0771-00-W	2"
B0772-00-W	3"
ZEBRA BRUSH SEAL*	
B0768-ZB-W	1"
B0771-ZB-W	2"
B0772-ZB-W	3"

*Colors are alternating yellow and black filament for high visibility.

GASKETING MATERIALS FOR FIRE DOORS

Classified to U.S. and Canadian standards by Underwriters Laboratories Inc. for application to hollow metal, steel covered composite, rolling steel and passenger elevator type fire doors rated up to three hours only. GVWZ.RI8008. Softening Point: 240°F, Melting Point: 320°F



weatherBLOCK WEATHERSEAL

WEATHERBLOCK WEATHERSEAL

Action Industries' standard weatherblock weatherseal ensures a secure seal and barrier against smoke, air infiltration and extreme weather. A single durable EPDM rubber insert provides an excellent seal. Fits all Standard Aluminum Retainers (see page 2). Standard Lengths: 8', 10'.

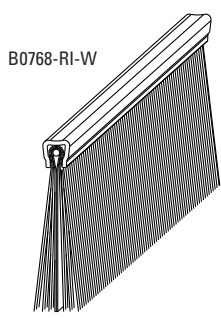

PART NUMBER	DESCRIPTION
BRUSH WEATHERSEAL	
B0766-RI-W	Standard 1/2" Brush
B0767-RI-W	Standard 3/4" Brush
B0768-RI-W	Standard 1" Brush
B0769-RI-W	Standard 1 1/2" Brush
B0770-RI-W	Standard 1 3/4" Brush
B0771-RI-W	Standard 2" Brush
B0772-RI-W	Standard 3" Brush

ACTION INDUSTRIES IS THE EXCLUSIVE DISTRIBUTOR OF FLEX BRUSH

Flex Brush is the convenient, money-saving alternative to traditional metal-back brush seals. Made of rugged yet lightweight and pliable materials, **Flex Brush** weighs up to 40% less than conventional brushes and is available on reels — drastically lowering shipping costs and streamlining production.

OTHER PHYSICAL PROPERTY ADVANTAGES:

- Eliminates scrap and splices
- Easy transport, storage, handling and installation
- Can be cut on-site to the exact length required
- Resistance against corrosion and chemicals
- Homogeneous bond between the backing material and the filament



*10+ Reels

PART NUMBER	DESCRIPTION
STANDARD FLEX SERIES	
B0768-PP-W	1" Standard Polypropylene Brush, 200' Reel
B0769-PP-W	1-1/2" Standard Polypropylene Brush, 200' Reel
B0771-PP-W	2" Standard Polypropylene Brush, 200' Reel
B0772-PP-W	3" Standard Polypropylene Brush, 100' Reel

ALUMINUM RETAINERS.

Fits our Standard Aluminum Retainers (See page 2).

Our CUSTOM FLEX SERIES can be customized to your specifications. Check out www.Flex-Brush.com to see how Flex Brush can help solve your industry challenge.



Go green with Flex Brush.
(Made with non-PVC, 100% recyclable materials.)



STANDARD RUBBER SEALS

Designed for applications where extreme temperature changes (-50° – 350°F) may occur. Designed to fit in our Standard Aluminum Retainers (see page 2) or Standard Rolling Steel Clip-On Retainers (see page 23). AVAILABLE IN ROLLS OR INSTALLED.

PART NUMBER	DESCRIPTION
V0036-00-W	1 1/8" Black
V0056-00-W	2 1/2" Black



STANDARD VINYL SEALS

These seals possess excellent memory for shape retention under various conditions at a reasonable cost. Designed to fit in our Standard Aluminum Retainers (see page 2) or Standard Rolling Steel Clip-On Retainers (see page 23). AVAILABLE IN ROLLS OR INSTALLED.

PART NUMBER	COLOR
V0021-GR-W	Gray
V0023-WH-W	White
V0024-BL-W	Black



PART NUMBER	COLOR
V0031-GR-W	Gray
V0033-WH-W	White
V0034-BL-W	Black



PART NUMBER	COLOR
V0041-GR-W	Gray
V0043-WH-W	White
V0044-BL-W	Black

